



ColecoVision Ultimate Pause Kit PAL Console Installation Guide



Table of Contents

Product overview2

What’s included2

Tools required2

How does it work?2

Installation instructions3

Rev A. All specifications and included hardware are subject to change.

<http://www.lundyelectronics.com>



Product overview

The Lundy Electronics **ColecoVision Ultimate Pause Kit** is the first pause mod offering designed to be completely hidden from view without any permanent modifications to the case.

This kit requires the user to be comfortable with disassembling the ColecoVision, have the ability to solder, and be comfortable cutting two circuit board traces. This document does not explain how to disassemble or reassemble the ColecoVision which can be found easily online.

What's included

- Populated Pause Mod PCB
- All necessary wiring
- Cable ties
- LED assembly with mounting bracket (option selected at time of purchase)
- Insulation pad



Pause Kit shown with both LED assembly options

Tools required

- X-Acto knife (with fine tip blade)
- Soldering iron
- Tin snips
- Flush cutting pliers
- Wire strippers
- Hot glue (optional)

How does it work?

The Lundy Electronics **ColecoVision Ultimate Pause Kit** uses a small microcontroller to monitor the existing factory reset push button to detect if the switch was held over a specified amount of time to enable pause mode or detect a simple press of the switch for a normal reset. To enable this capability, one trace will need to be cut to isolate the reset switch from the original circuitry to allow the microcontroller to monitor it and send out a reset pulse as needed. This modification is totally seamless, and there is no indication anything has changed for the end user. If the microcontroller detects a long press of the reset switch, the controller will illuminate or change an LED assembly effect to notify the user it is safe to let go of the reset switch to enable pause mode. During pause mode, an analog switch IC controlled by the microcontroller is used to force the Z80 /WAIT low to freeze the system and opens the audio line to disable any sound that may have remained active while pause was initiated. During pause, the LED assembly will change depending on configuration to show that pause is active. A regular reset push will exit pause mode and continue where you left off.

Rev A. All specifications and included hardware are subject to change.

<http://www.lundyelectronics.com>

Please read these instructions in their entirety before performing this installation.

Installation instructions

Note: Your Pause Kit has been tested carefully by Lundy Electronics which includes visual inspection under a microscope, full bench testing, and heat stress testing to insure no faulty solder joints or issues. We guarantee that this product is fully operational, and Lundy Electronics is not responsible for damages caused by static discharge, improper handling, incorrect installation, or damage caused by soldering.

With the ColecoVision and RF modulator PCBs completely removed from the case, perform the following steps.

Step 1: Using an X-Acto knife, very carefully cut the following two PCB traces. See **Figure 1** for reset line cut and **Figure 2** for audio line cut.

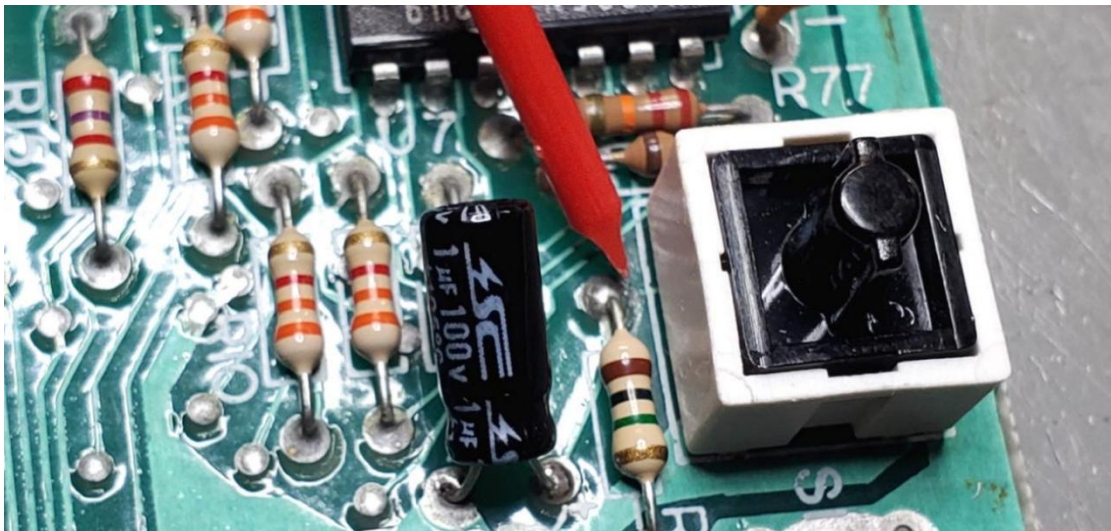

Figure 1: Reset line cut

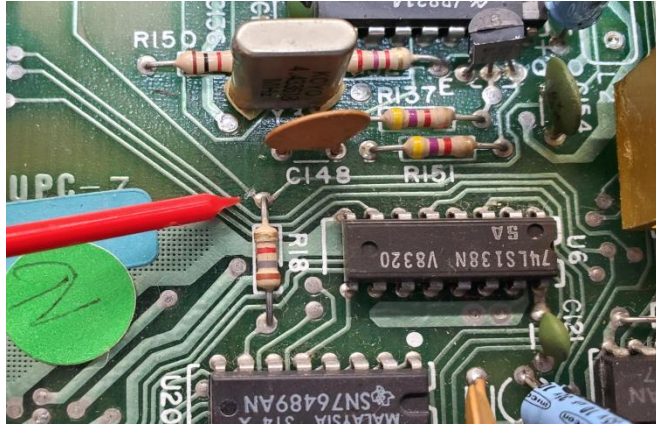

Figure 2: Audio line, cut trace at top left side of R18

Step 2: Solder the following wires from the kit to the designated solder locations of the ColecoVision bottom side PCB.

Solder the two green wires to audio connections. See **Figures 3a and 3b.**

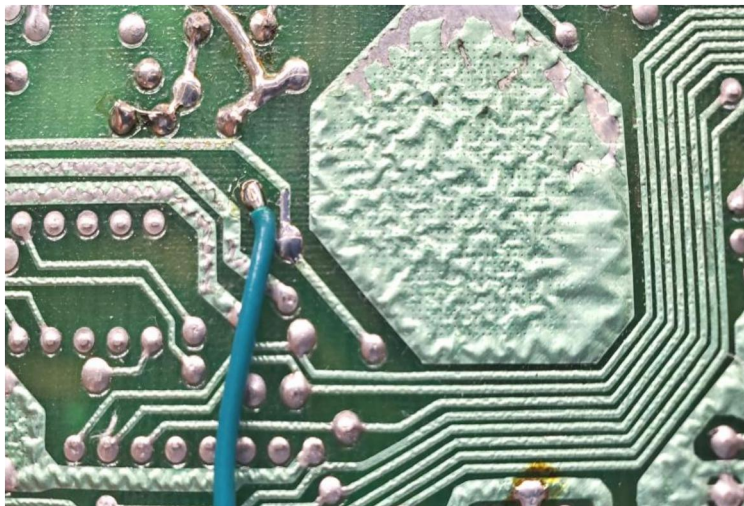

Figure 3a: Solder first green wire to audio connection

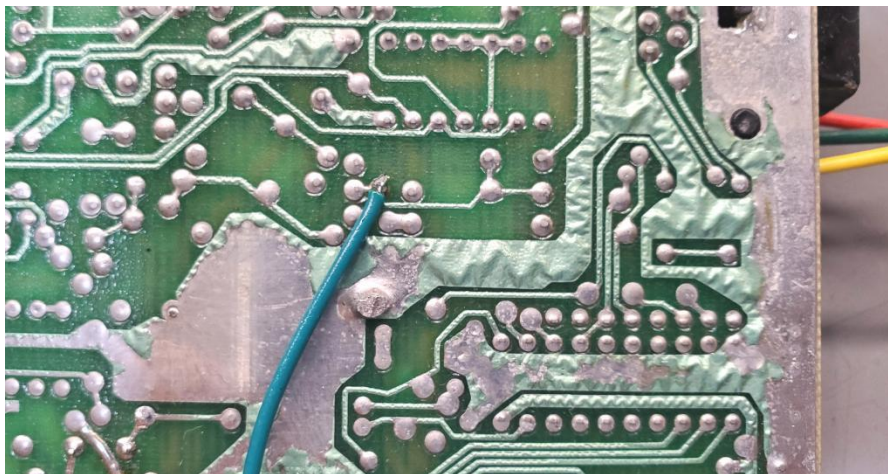

Figure 3b: Solder second green wire to audio connection

Solder white and blue wires to reset connections. See **Figure 4**.

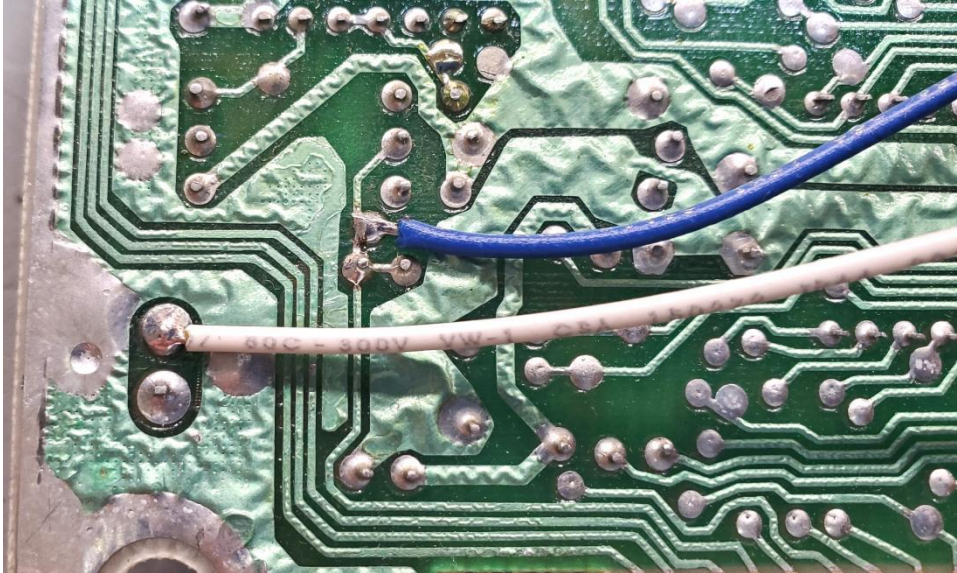

Figure 4: Solder white and blue wires to reset connections

Solder red (+5) and black (GND) to power connections. See **Figure 5**.

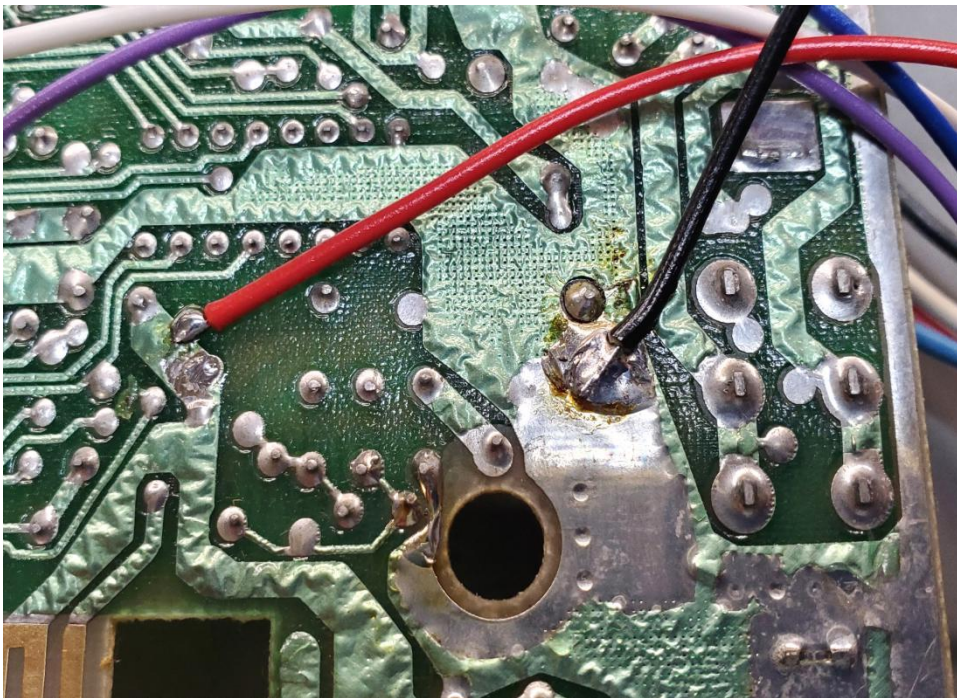

Figure 5: Solder red and black to power connections

Solder violet wire to Z80 /WAIT pin 24 connection. See **Figure 6**.

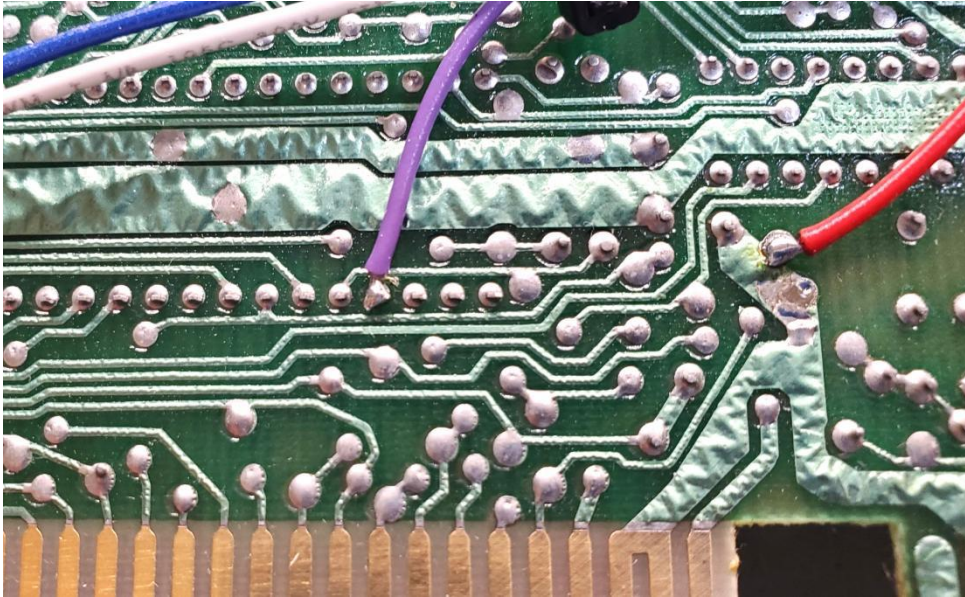

Figure 6: Solder violet wire to Z80 /WAIT connection

Verify all connections. See **Figure 7**.

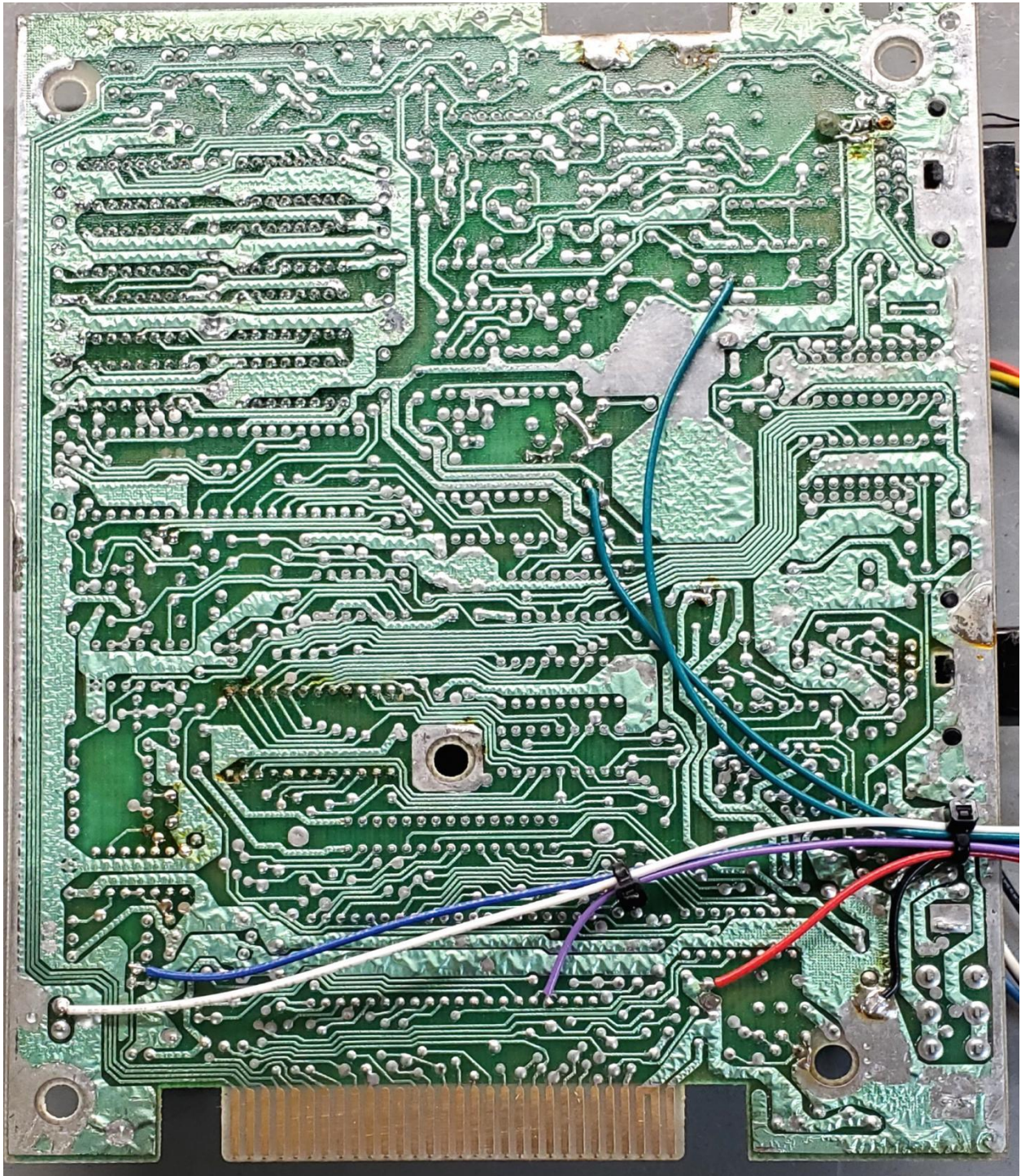

Figure 7: Verify all connections

Step 3: Flip the ColecoVision PCB to show the top side on the PCB. Cleanly trim, strip, and solder main wiring harness to the Pause Mod PCB as follows. See **Figures 8a and 8b**.

- Solder black wire to GND pad.
- Solder red wire to VCC pad.
- Solder green wires to AUDIN and AUDOUT pads (order doesn't matter).
- Solder blue wire to /RSTOUT pad.
- Solder white wire to /RSTIN pad.
- Solder violet wire to /WAIT pad.

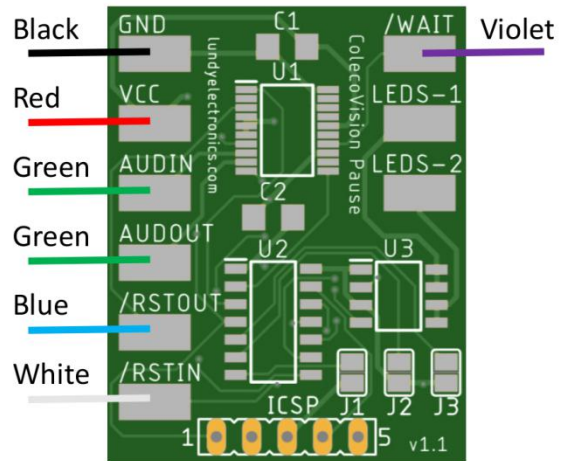

Figure 8a: Main wiring harness diagram

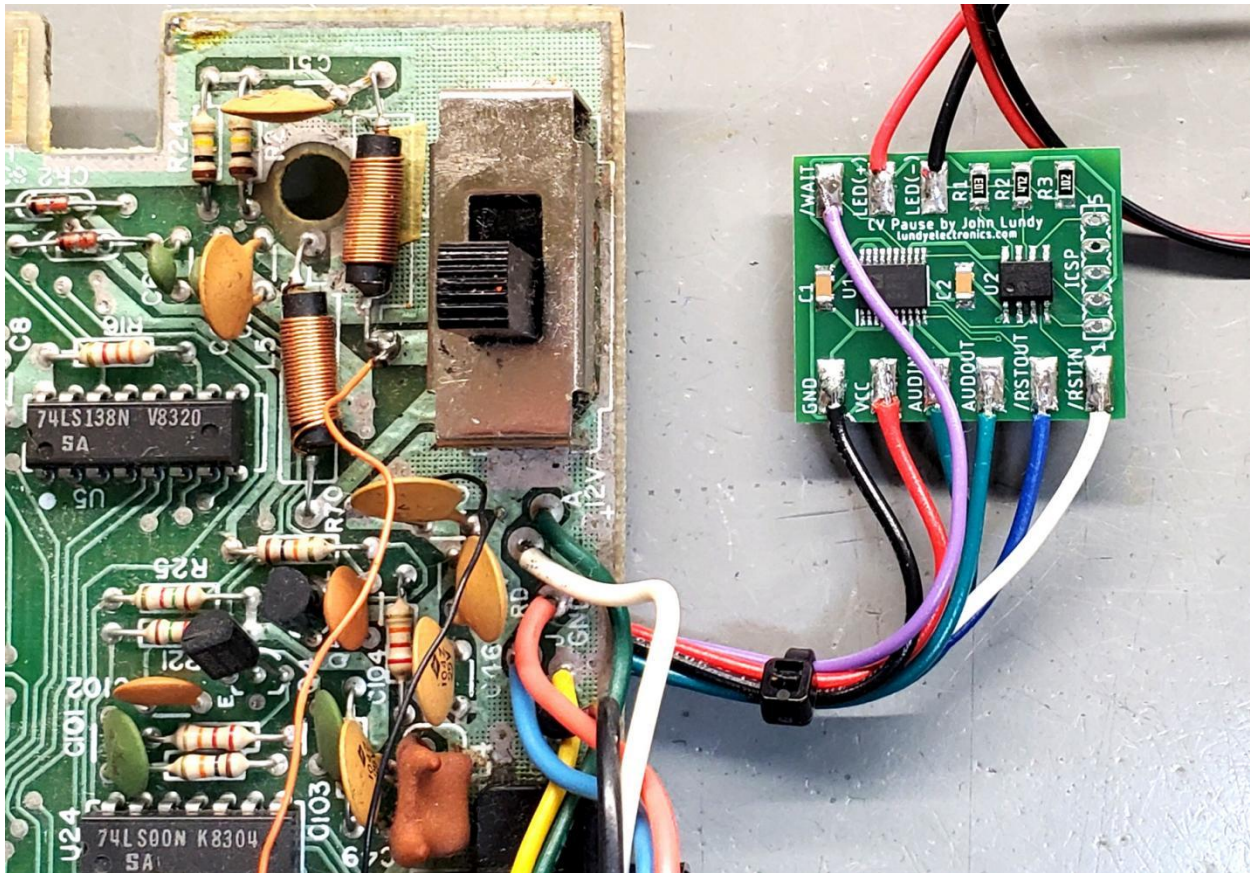

Figure 8b: Cleanly trim, strip, and solder wires to the Pause Mod PCB

Note: Picture may vary depending on PCB version. Reference Figure 8a for current version.

Step 4: Solder LED wiring harness wires to the Pause Mod PCB as indicated. See **Figures 8c and 8d** depending on LED assembly selected.

Single LED Solder Pad Configuration (* - recommended)

Figure 8c: Single LED mode wiring diagram option

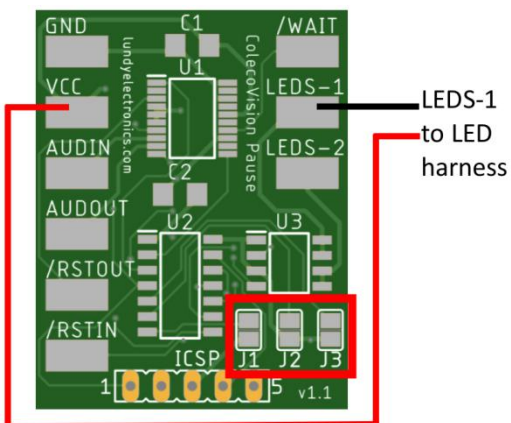

Single LED Configuration Options

- J1 **Must** be **OPEN** (single LED mode)
- Options
- J2 Power-on fade effect
*CLOSED: no fade or OPEN: fade
 - J3 LED always on in normal operation
CLOSED: LED always on / fade on pause or *OPEN: only fade on pause

Dual LED Solder Pad Configuration (* - recommended)

Figure 8d: Dual LED mode wiring diagram option

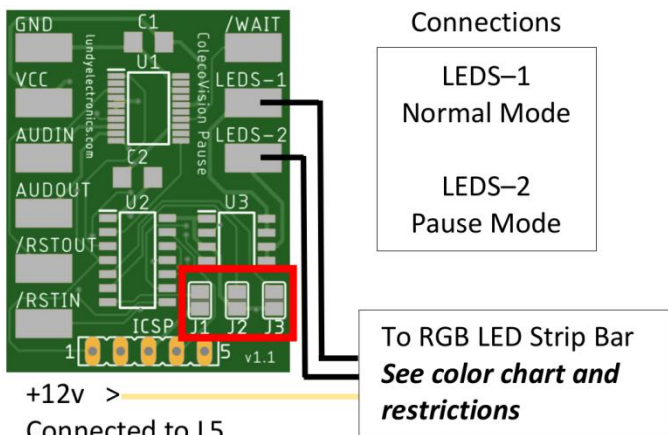

Dual LED Configuration Options

- J1 **Must** be **CLOSED** (dual LED mode)
 - J3 **Must** be **OPEN** (dual LED mode)
- Options
- J2 Power-on fade effect
*CLOSED: no fade or OPEN: fade

(lower side closest to mounting hole near power switch, see **Figure 8e**)

LED Color Chart

- Red
- Blue
- Green
- Red + Blue = Violet
- Green + Blue = Teal
- Green + Red = Yellow

Restrictions and Notes

No same color or color combination can be attached to both LEDs-1 and LEDs-2 solder pads.

Red is typically dedicated to LEDs-2 for pause color.

Step 5: Verify all connections and work performed so far. Look closely for shorts to adjacent pins/pads and traces.

Step 6: Install ColecoVision PCB without RF shields into lower case housing and safely rest the RF modulator PCB off to the side to test unit for proper operation. See **Figure 9** for proper orientation of Pause Mod placement.

Step 7: Connect the ColecoVision video, audio, power source, and joystick connections as normal and power on the unit. Perform the following steps to conclude initial testing. If any of these steps fail, immediately turn off the unit and verify all work was performed correctly.

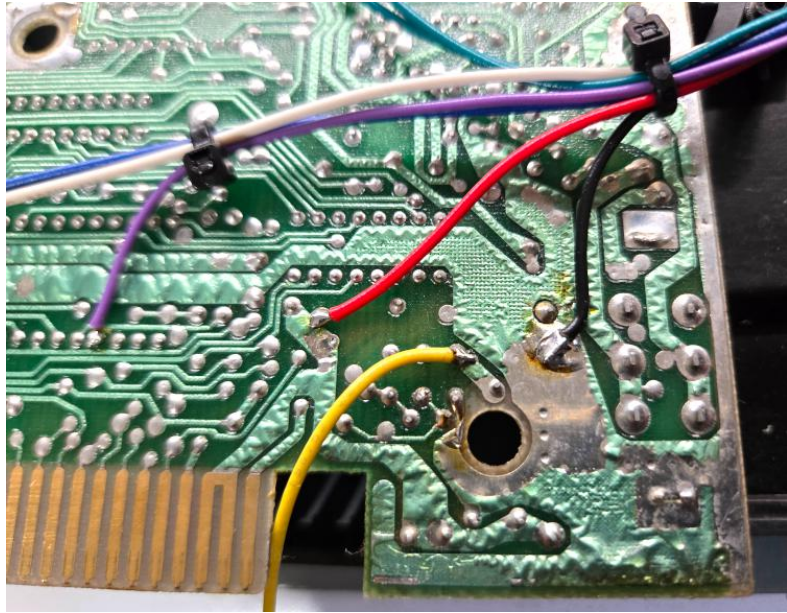

Figure 8e: Yellow 12V wire connection shown

- Verify unit powers up and displays the normal “Insert Cartridge” message to verify unit is operational
- Press the reset button to verify the unit performs a normal reset.
- Power off unit and insert a cartridge and power on.
- Start a game and then hold the reset switch until the configured LED assembly pause mode effect illuminates and then let go to verify unit is paused and audio is no longer present. The indicator LED should perform configured pause mode effect while paused.
- Press the reset button normally to verify pause mode stops and audio is present, LED assembly reverts back to normal configured operating mode, and game continues as normal.

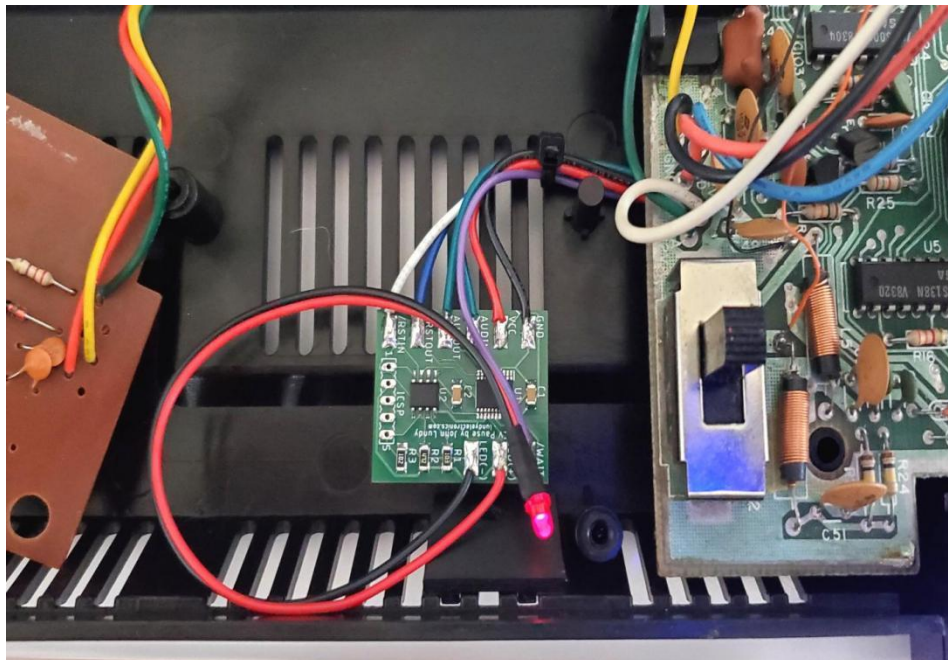

Figure 9: Proper orientation of Pause Mod placement

Note: Picture may vary depending on PCB version.

Step 8: Remove PCB from lower housing and install wire cable ties as shown in **Figure 10**.

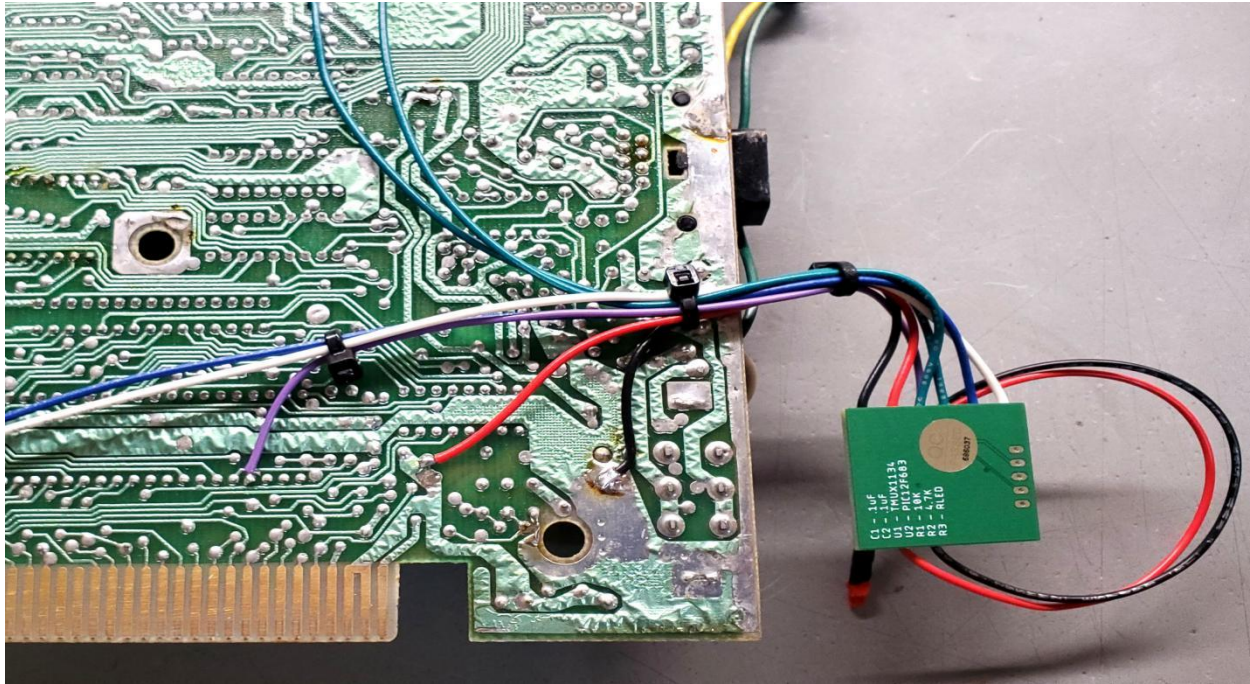

Figure 10: Install wire tie wraps

Step 9: Install the LED assembly mounting bracket in the empty lower case housing as shown for proper placement and orientation. Peel off the double-sided mounting tape backing and firmly press the bracket in place as shown. For single LED assembly option, follow **Figures 11a and 11b**. For dual LED light bar assembly option, follow **Figures 11c and 11d**.

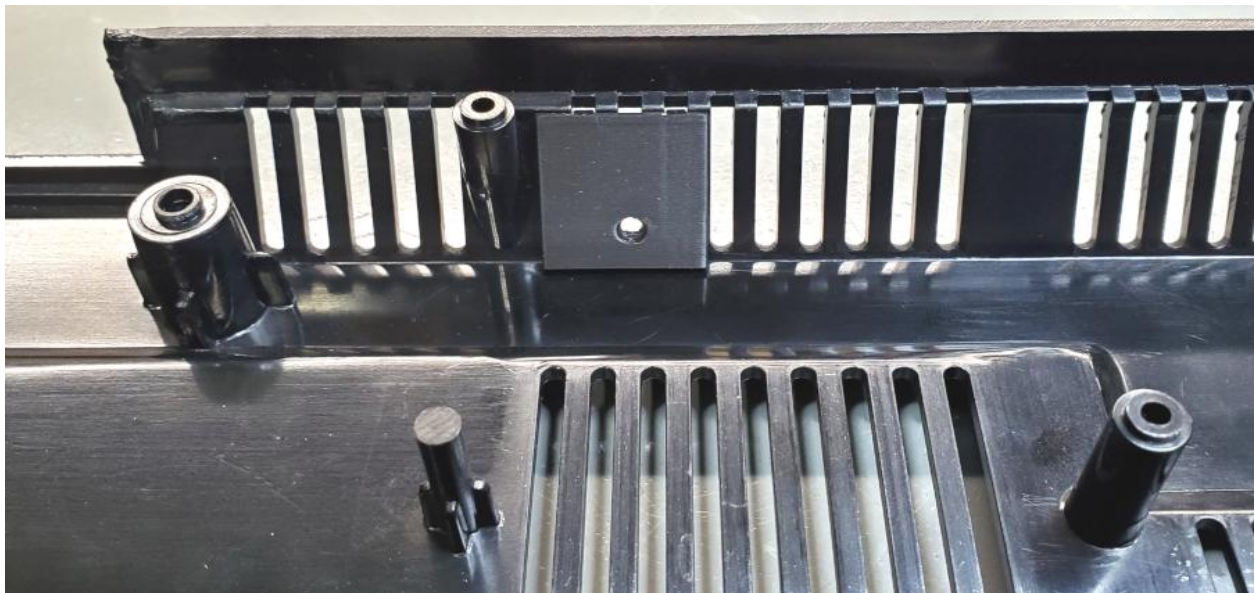

Figure 11a: Single LED mounting bracket placement in lower case housing

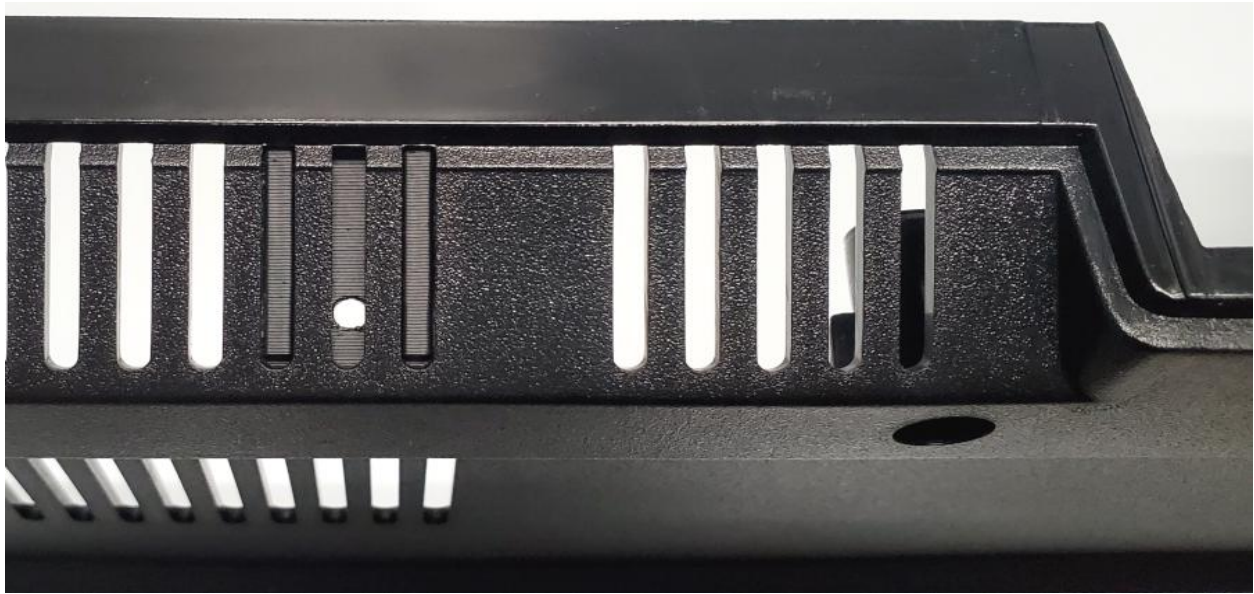

Figure 11b: Single LED mounting bracket placement in lower case housing

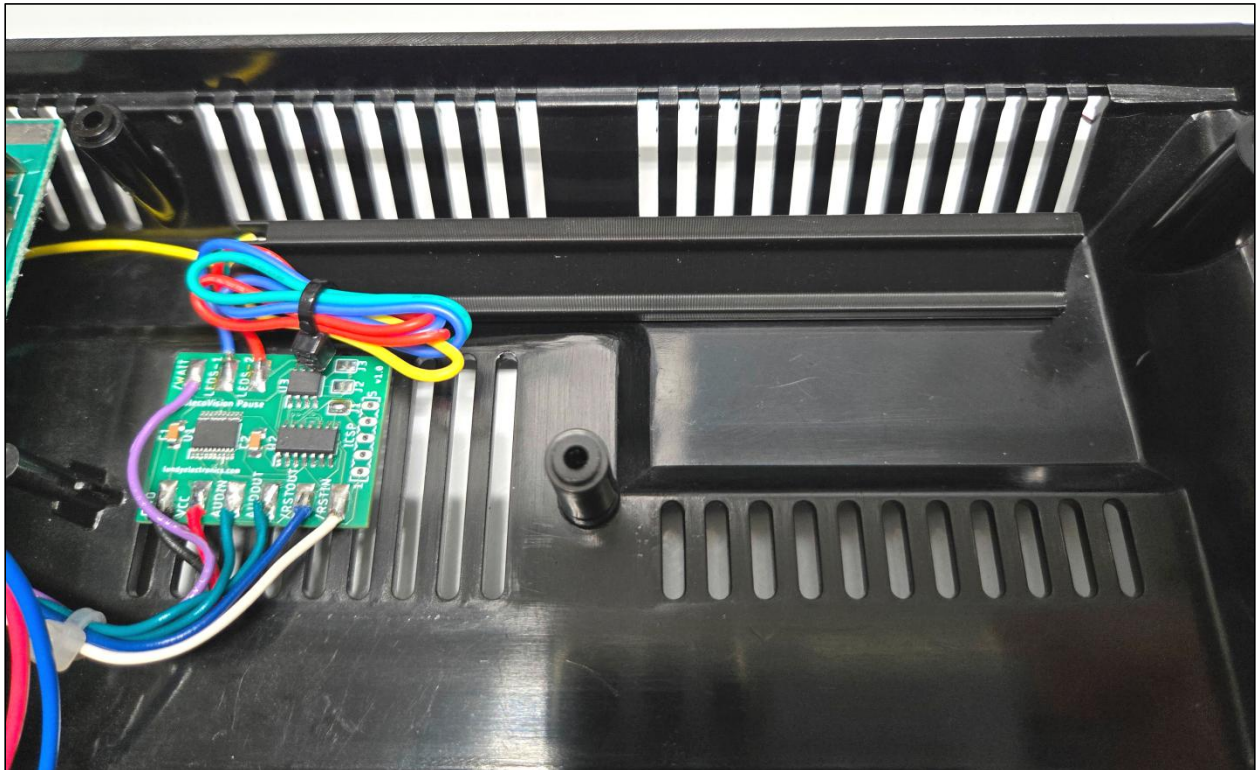

Figure 11c: Dual LED light bar assembly placement in lower case housing



Figure 11d: Dual LED light bar assembly placement in lower case housing

Step 10: The lower shield requires adding a notch with tin snips to the lower RF shield to make room for the new Pause Mod controller wiring. See **Figure 12**.

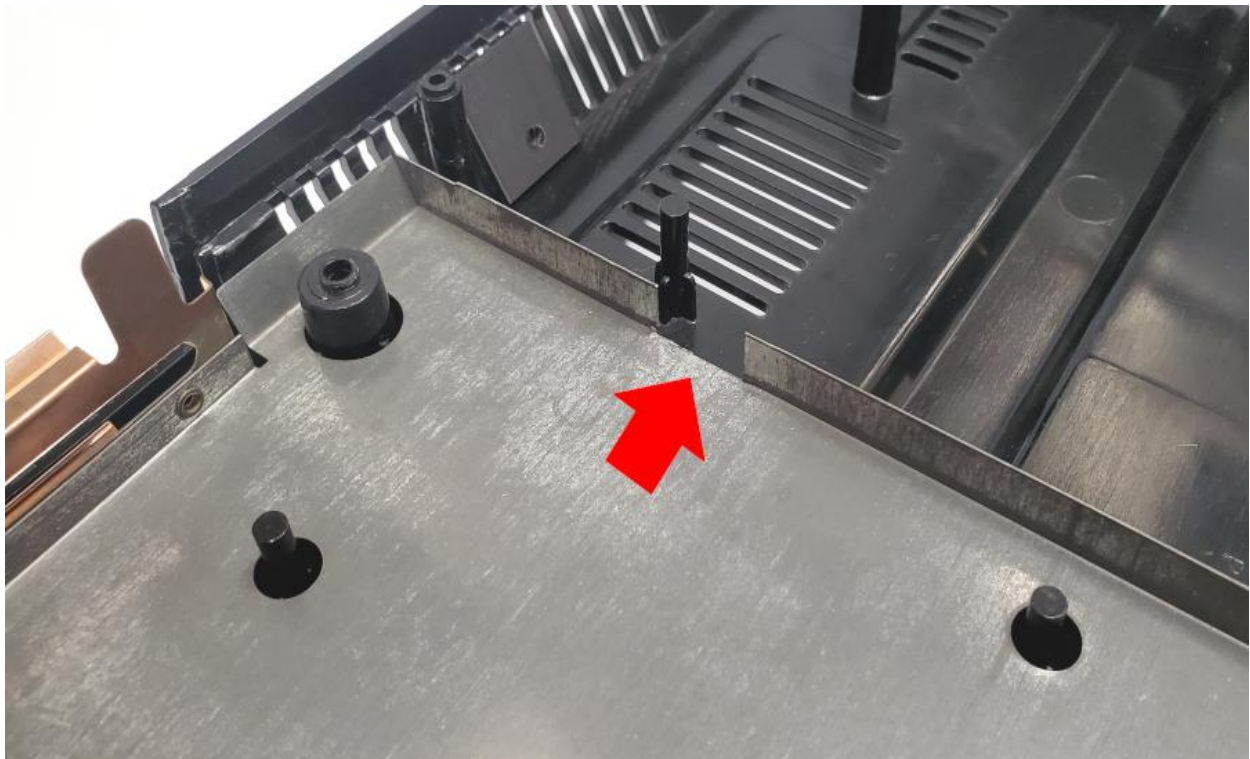

Figure 12: Add notch to lower shield

Step 11: Reinstall PCB for final mounting installation, place the Pause Mod PCB as shown in **Figure 13**. If single LED assembly option was installed, push the indicator LED into the mounting bracket. It is designed to fit snugly so it can be removed later if needed. Hot glue can be used to hold it more securely if desired.

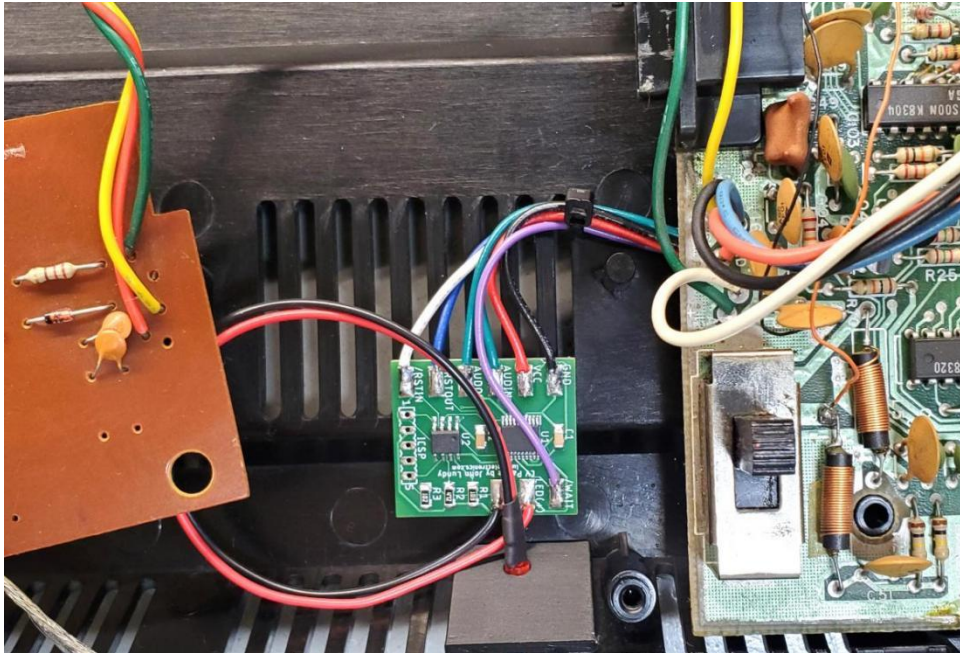

Figure 13: Placement of Pause Mod PCB with single LED assembly

Note: Picture may vary depending on PCB version. Reference Figure 8a for current version.

Note: The Pause Mod PCB is designed to stay loosely in place without the need for permanent mounting to make servicing easier in the future.

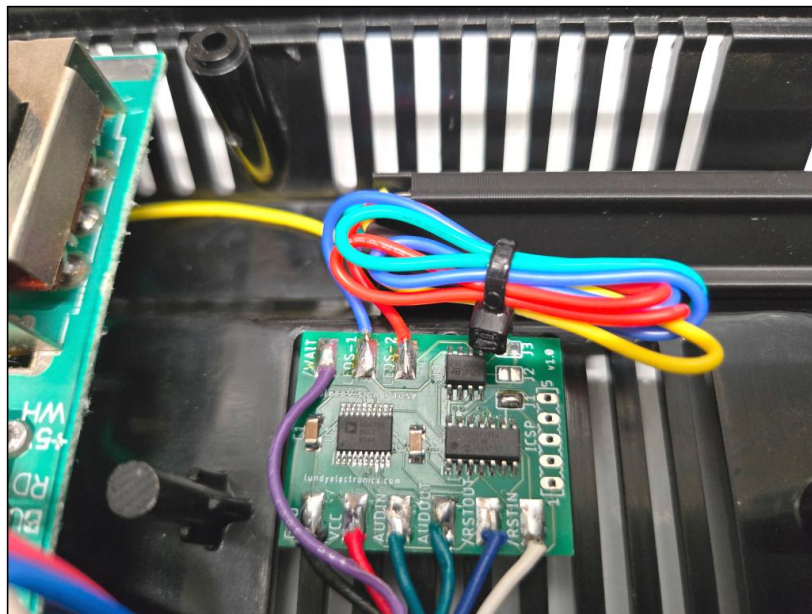

Figure 14: Placement of Pause Mod PCB with dual LED assembly bar

Example configuration shown

- Blue normal
- Red pause mode
- Green not used

Note: Picture may vary depending on PCB version. Reference Figure 8a for current version.

Step 12: Install the RF modulator PCB insulator to the bottom of the PCB as shown in **Figure 15** and mount PCB.

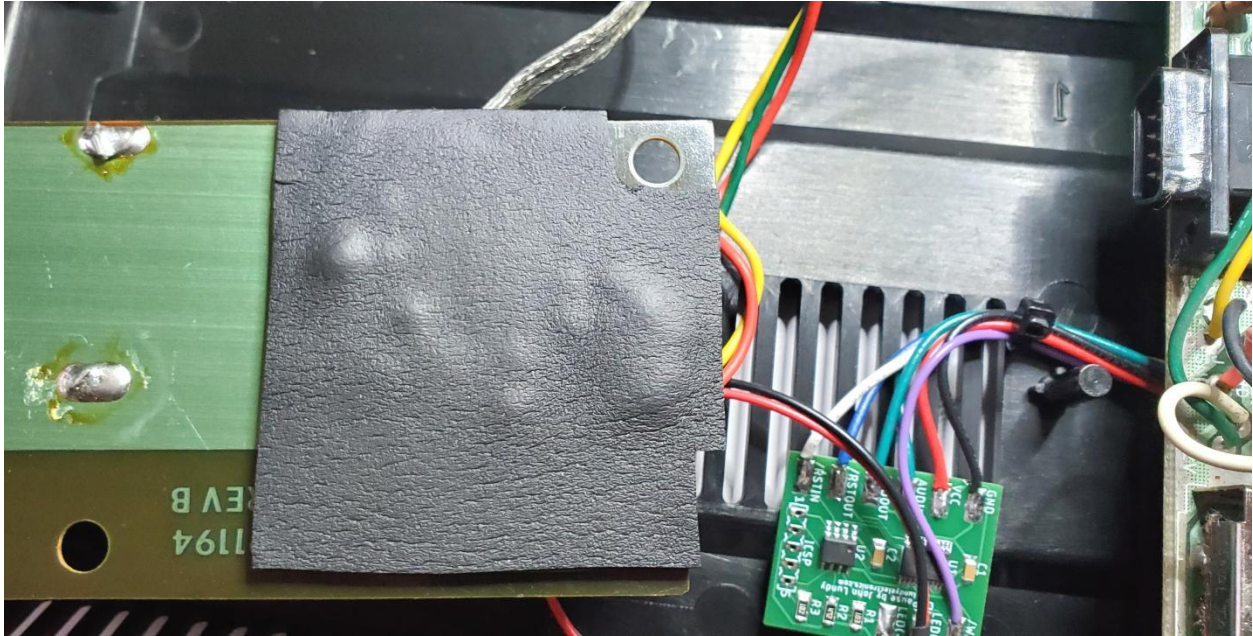
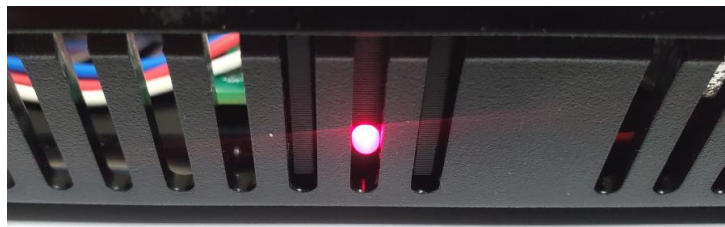

Figure 15: Placement of RF modulator PCB insulator

Step 13: Before completely closing the ColecoVision back up, first perform the same test procedure in Step 6 again to verify everything is working correctly.

Installation is now complete.

Thank you for choosing Lundy Electronics, and we hope you enjoy your ColecoVision product.



Single LED option



Dual LED option